

The EMS-81X is a compact, powerful loudspeaker - the workhorse of the EMS Series. The EMS-81X is ideal for a wide range of applications ranging from small front-of-house duties to compact stage monitoring. Utilising our latest passive crossover topologies, and the utmost in drive unit technology, this loudspeaker is completely passive yet outperforms many bi-amplified or processed designs.

FEATURES AND BENEFITS

- Asymmetrical multi-angled cabinet for FOH or stage monitor use
- Genuine plywood cabinet for sonic benefit over plastic
- 8" neodymium LF, 1" exit neodymium HF drive units
- True passive design - no corrective DSP required
- Rotatable 90° x 60° waveguide
- 35mm pole mount
- Flexible rigging and mounting options
- Compatible with OmniMount™ and Powerdrive brackets
- Impact and weather resistant black, and textured white finishes as standard
- RAL colour and weather protection options

APPLICATIONS

- Small to medium theatre and touring events
- Small to medium live sound reinforcement
- Houses of worship
- Conference, corporate and audio-visual
- Theme parks



The EMS-81X is a two-way passive loudspeaker, using a 2" voice coil 8" (203mm) low frequency transducer. This low frequency drive unit is coupled via the internal passive crossover network to a 1.7" (44mm) diaphragm, 1" (25mm) exit neodymium high frequency transducer. This drive unit loads onto a rotatable 90° x 60° constant-coverage horn, which yields not only consistent response throughout its operating band across the whole coverage pattern but also strong attenuation outside of this pattern. The result is a loudspeaker with extremely consistent and predictable coverage, as well as stunning sonic detail – and all with the ease of use that passive crossover technology brings.

The drive units are housed within a compact, vented enclosure. The robust enclosure is constructed from premium 15mm (5/8") multi-laminate Birch plywood, and is heavily braced to minimise panel reflection. Five M8 threaded fixings are incorporated around the enclosure (two top, two bottom and one on the rear) for attachment of optional rigging hardware and safeties. Four M6 threaded fixings on the rear of the enclosure are

compatible with OmniMount™ Series 30 and Powerdrive™ Series 75 bracket products. A 35mm pole mount socket is provided discretely on the underside for stand mounting. The enclosure also includes a flush handle on the rear, and a pair of Neutrik® speakON™ NL4 connectors for input and enclosure link. Lastly, a tough hex-punched grille backed with acoustically transparent fabric protects the drive units from damage. The grille can be quickly removed for service purposes or to rotate the HF waveguide – the orientation of which can be determined without removing the grille. The enclosure is finished in black impact and water-resistant polyurethane or white textured paint as standard, however RAL colour matching and increased weather resistant options are also available.

The EMS-81X requires a single amplifier channel, and should be used with professional power amplifiers capable of delivering 400-500W RMS into an 8-ohm load. For optimal results, the DQ Series Advanced System Amplifiers should be used.

TECHNICAL SPECIFICATIONS

ENCLOSURE TYPE:	Two-way passive, reflex loaded
DIMENSIONS (HxWxD)	462 (18.2) x 262 (10.3) x 261 (10.3) mm/(ins)
NET/SHIPPING WEIGHT:	13/14kg (28.6/30.8lbs)
FREQUENCY RESPONSE¹:	75Hz – 20kHz ±3dB
SENSITIVITY²:	95dB
DISPERSION³:	90° x 60°, rotatable
DRIVE UNITS:	8" (203mm) LF cone drive unit 1" (25mm) exit neodymium HF compression drive unit
LOUDSPEAKERS PER AMPLIFIER	DQ6: 2 per channel, DQ10: 4 per channel, DQ20: 4 per channel
POWER HANDLING:	250W RMS, 500W program
MAXIMUM SPL⁴:	120dB continuous, 126dB peak
NOMINAL IMPEDANCE:	8 ohms
CROSSOVER:	Asymmetric internal passive
CONNECTORS:	2 x Neutrik® speakON™ NL4
ENCLOSURE:	15mm (5/8") multi-laminate Birch plywood – rebated, screwed and glued. Finished in impact and weather resistant black polyurethane, or textured white paint
RIGGING & HARDWARE:	5 x M8 threaded mounting points 4 x M6 threaded points for OmniMount™ Series 30/Powerdrive™ Series 75 brackets 1 x flush handle on rear, 1 x 35mm pole mount socket
GRILLE:	Hex punched steel backed with acoustically transparent fabric
OPTIONS:	Colours/Weather Protection
ACCESSORIES:	FC-81Xv vertical flying cradle FC-81Xh horizontal flying cradle DFB-81X dual enclosure flying plate set
SPARE PARTS:	DU-802 8" drive unit CDU-1001A 1" exit HF compression drive unit PX-81X passive crossover assembly RFG-81X replacement grille/fabric

NOTES ON MEASUREMENT CONDITIONS:

¹Measured on-axis at 2m in an anechoic environment and referenced to 1m. ²Measured in half space at 2m with 4W sine wave input and referenced to 1m. ³Nominal dispersion, measured in an anechoic environment and averaged over stated bandwidth. ⁴Calculated and verified by subjective listening test of familiar program material.

RIGGING ACCESSORIES

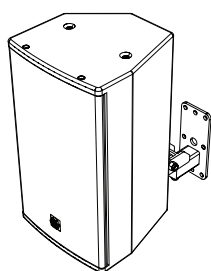

WHH75

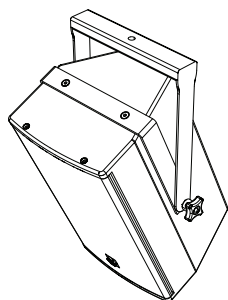

FC-81Xv

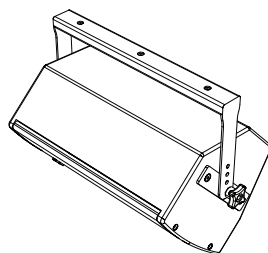

FC-81Xh

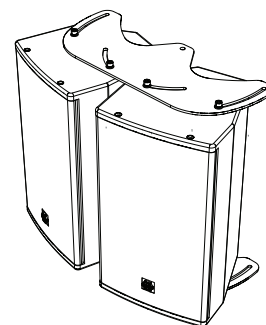

DFB-81X

ENCLOSURE OPTIONS

EMS-81X enclosures are available as standard in black 3-step impact resistant polyurethane finish, or white water-based Wamex textured paint. Custom RAL colours can be supplied on request; extended lead times and set up costs apply. EMS-81X enclosures can also be supplied as an outdoor version (OD), finished in the same black weather-resistant 3-step polyurethane coating, with stainless steel grilles and weather-resistant connector options, and other cabinet details bespoke to the customer's request. Custom RAL colours are also available for outdoor options by specific quote. Please contact your local EM Acoustics representative for details.

ENGINEERING DRAWING

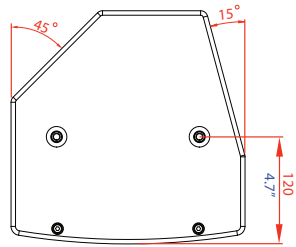

TOP

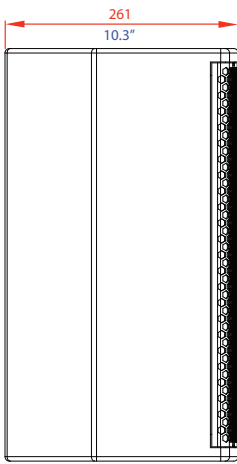

LEFT

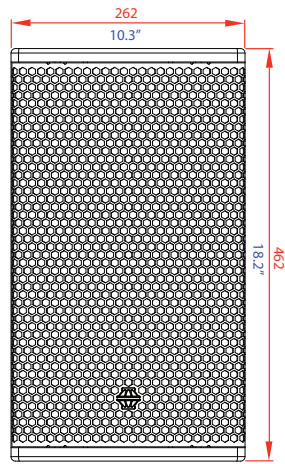

FRONT

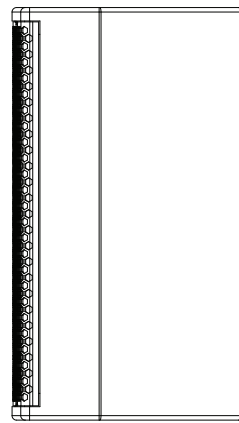

RIGHT

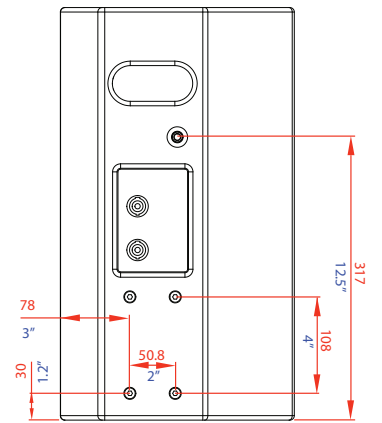

REAR

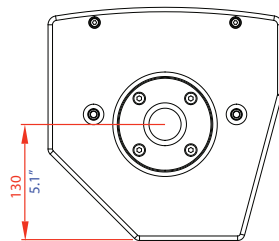

BOTTOM