

The ESP-8 is a compact, versatile self-powered loudspeaker – small enough to be discreet in use, yet with an output that defies its diminutive size. The ESP-8 is ideal for a wide variety of applications ranging from small front-of-house duties to speech reinforcement, front fill or compact stage monitoring. The onboard amplification and DSP package make the ESP-8 completely self-contained.

FEATURES AND BENEFITS

- Coaxial design for true point source performance
- Compact, lightweight, multi-angle enclosure
- Self-contained control and amplification package
- Wide, conical dispersion pattern
- Intuitive, swift rigging options
- Universal mains voltage operation
- 35mm pole mount socket

APPLICATIONS

- Theatre
- Houses of worship
- Conference, corporate and audio-visual
- Theme parks

The ESP-8 is a two-way loudspeaker, using a 2" voice coil 8" (203mm) neodymium low frequency transducer and a 2" (51mm) diaphragm 1" (25mm) exit coaxially-loaded high frequency transducer. The coaxial drive unit arrangement provides a uniform 100° conical dispersion pattern, with very smooth off-axis response and no parallax effects that would be present with separate LF and HF drive units. The result is a compact loudspeaker that provides excellent performance in a wide range of applications – from compact FOH use to powerful stage monitoring.

The ESP-8 utilises the latest in Class D amplifier technology, with a compact and lightweight module delivering a total power of 1200W RMS between the two drive units. Separate channels drive the low and high frequency transducers, allowing the ESP-8 to make the best use of the latest DSP for both performance as well as reliable limiting. The amplifier power supply is a universal voltage design, meaning the ESP-8 will operate happily across the globe. The amplifier is primarily passively cooled via the substantial heatsink on the rear of the enclosure, however for high temperature scenarios a fan is present within the loudspeaker itself to cool critical components in the high-demand scenarios. Four application-specific presets are available in the ESP-8 – for stand-alone use, flat response, use with a subwoofer, and stage monitoring applications. All

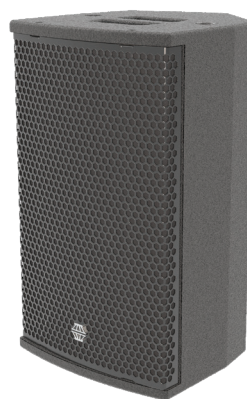

functions are handled by the DSP including crossover, time alignment, and drive unit protection.

The ESP-8 has a combination XLR/1/4" jack input, and a male XLR link output. LED indicators for power, status and preset are provided on the rear panel, along with preset selection controls and a level control, and mains supply is handled by Neutrik® PowerCON True1 inlet and link output connectors. The ESP-8 also comes supplied with a 3m True1 power cable, as well as the loose link output connector for assembling link mains cables.

The drive unit is housed within a compact, vented enclosure. The robust enclosure is constructed from premium 15mm (5/8") multi-laminate Birch plywood and is heavily braced to minimise panel resonance. Five M8 threaded rigging points are provided (two top, two left, one on the rear right) to attach the optional rigging accessories and safeties, a 35mm polemount is provided on the base for stand mounting, and a flush bar handle is positioned on the top for easy lifting of the 13.2kg (29lbs) loudspeaker. Lastly, a tough hex-punched steel grille backed with acoustically transparent fabric protects the drive units from damage – this grille can quickly and easily be removed for service purposes.

TECHNICAL SPECIFICATIONS

ACOUSTICAL & MECHANICAL

| | |
|---------------------------------|---|
| ENCLOSURE TYPE: | Two-way, coaxial reflex loaded, self-powered |
| DIMENSIONS (HxWxD) | 468 (18.4) x 272 (10.7) x 291 (11.5) mm/(ins) |
| NET/SHIPPING WEIGHT: | 13.2kg/14.5kg (29/32lbs) |
| FREQUENCY RESPONSE ¹ | 65Hz – 20kHz ±3dB |
| DISPERSION ² | 100° conical |
| DRIVE UNITS | Coaxial neodymium 8" (203mm) LF/1" (25mm) exit HF |
| MAXIMUM SPL ³ | 120dB continuous, 126dB peak |
| CROSSOVER | Onboard DSP-based active |
| CONNECTORS | Neutrik combi XLR/Jack input, male XLR output PowerCON True1 inlet/link output |
| ENCLOSURE: | 15mm (5/8") multi-laminate Birch plywood – rebated, screwed and glued Finished in semi-matt textured paint |
| RIGGING & HARDWARE: | 5 x M8 exposed-thread rigging points 35mm polemount, 1 x flush bar handle |
| GRILLE | Fabric-backed perforated steel |
| OPTIONS: | Colours |
| ACCESSORIES | FC-P8v vertical flying cradle, FC-P8h horizontal flying cradle |
| SPARE PARTS | CAD-801 8"/1" coaxial drive unit RFG-ESP8 replacement grille RD-C801 replacement HF diaphragm |

AMPLIFIER PACKAGE

| | |
|-------------------|--|
| AMPLIFIER TYPE: | Dual channel Class D |
| AMPLIFIER POWER: | 800W LF, 400W HF (total power available) |
| DSP SYSTEM | 24 bit 48kHz Analog Devices SigmaDSP |
| COOLING | Passive heatsink, reserve internal fan |
| OPERATING VOLTAGE | 100-240V, 50-60Hz AC with PFC |

NOTES ON MEASUREMENT CONDITIONS:

¹Measured on-axis at 2m in an anechoic environment and referenced to 1m. ²Nominal dispersion, measured in an anechoic environment and averaged over stated bandwidth. ³Calculated and verified by subjective listening test of familiar program material.

RIGGING ACCESSORIES

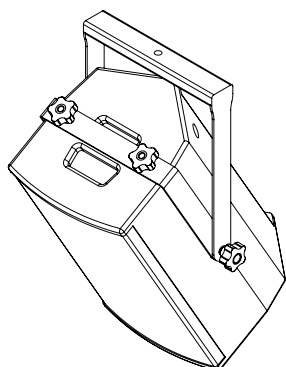

FC-P8v vertical cradle

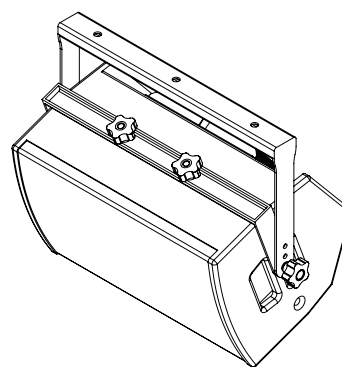

FC-P8h horizontal cradle

ENCLOSURE OPTIONS

ESP Series loudspeakers are available as standard in black or white finish. Custom RAL colours can be supplied on request; extended lead times and set up costs apply. Please contact your EM Acoustics representative for details.

ENGINEERING DRAWING

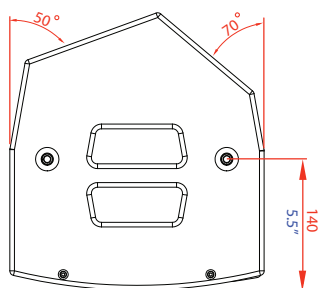

TOP

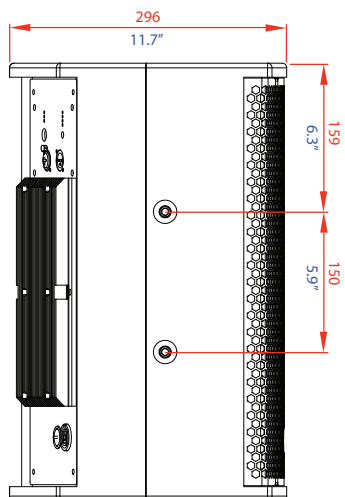

LEFT

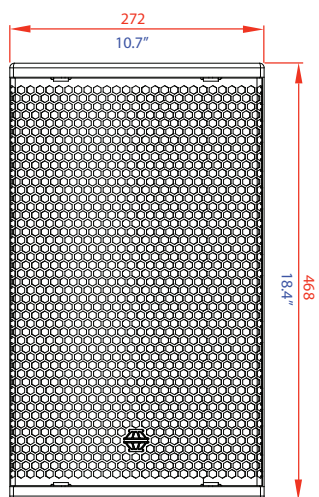

FRONT

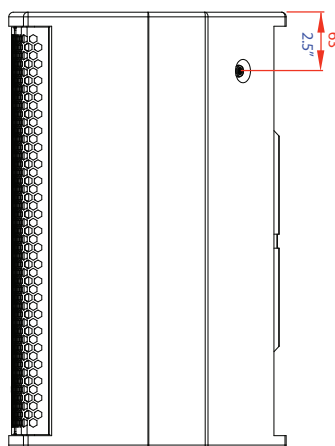

RIGHT

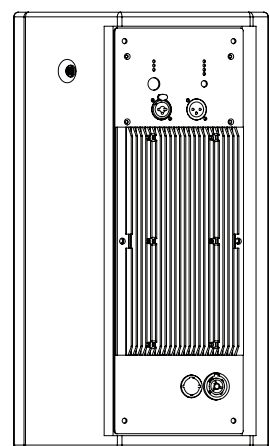

REAR

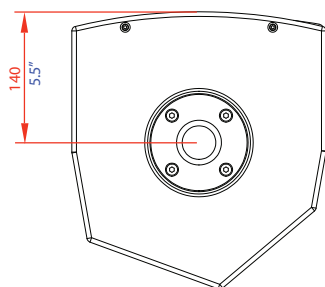

BOTTOM